

3481-20 VOLTAGE DETECTOR

Instruction Manual

EN

Sept. 2020 Revised edition 1
3481D980-01 20-09H



HIOKI

<http://www.hioki.com>



All regional
contact
information

HEADQUARTERS
81 Koizumi
Ueda, Nagano 386-1192 Japan

HIOKI EUROPE GmbH
Rudolf-Diesel-Strasse 5
65760 Eschborn, Germany
hioki@hioki.eu

1906 EN

Edited and published by HIOKI E.E. CORPORATION

Printed in Japan

- CE declarations of conformity can be downloaded from our website.
- Contents subject to change without notice.
- This document contains copyrighted content.
- It is prohibited to copy, reproduce, or modify the content of this document without permission.
- Company names, product names, etc. mentioned in this document are trademarks or registered trademarks of their respective companies.

Visual and audible
voltage detection indication

Auto Power OFF

Model 3481-20
Ideal for 100 V to 120 V installations.



Sensitivity-adjustable

Introduction

Thank you for purchasing the HIOKI "Model 3481-20 VOLTAGE DETECTOR." To obtain maximum performance from the instrument, please read this manual first, and keep it handy for future reference.

Overview

This non-contact type of voltage detector unit enables the hot-line state of AC voltage to be checked through the wire or cable covering

Initial Inspection

When you receive the instrument, inspect it carefully to ensure that no damage occurred during shipping. If damage is evident, or if it fails to operate according to the specifications, contact your dealer or Hioki representative.

Maintenance and Service

- To clean the instrument, wipe it gently with a soft cloth moistened with water or mild detergent. Never use solvents such as benzene, alcohol, acetone, ether, ketones, thinners or gasoline, as they can deform and discolor the case.
- If the instrument seems to be malfunctioning, confirm that the batteries are not discharged, before contacting your dealer or Hioki representative.

Safety

This manual contains information and warnings essential for safe operation of the instrument and for maintaining it in safe operating condition. Before using it, be sure to carefully read the following safety precautions.

⚠ DANGER

This instrument is designed to comply with IEC 61010 Safety Standards, and has been thoroughly tested for safety prior to shipment. However, mishandling during use could result in injury or death, as well as damage to the instrument. Be certain that you understand the instructions and precautions in the manual before use. We disclaim any responsibility for accidents or injuries not resulting directly from instrument defects.

Safety Symbol

	In the manual, the ⚠ symbol indicates particularly important information that the user should read before using the instrument. The ⚠ symbol printed on the instrument indicates that the user should refer to a corresponding topic in the manual (marked with the ⚠ symbol) before using the relevant function.
	Indicates a double-insulated device.
	Indicates AC (Alternating Current).
	Indicates DC (Direct Current).

The following symbols in this manual indicate the relative importance of cautions and warnings.

⚠ DANGER	Indicates that incorrect operation presents an extreme hazard that could result in serious injury or death to the user.
⚠ WARNING	Indicates that incorrect operation presents a significant hazard that could result in serious injury or death to the user.
⚠ CAUTION	Indicates that incorrect operation presents a possibility of injury to the user or damage to the device.
NOTE	Indicates advisory items related to performance or correct operation of the instrument.

Symbols for Various Standards

	Indicates the Waste Electrical and Electronic Equipment Directive (WEEE Directive) in EU member states.
	Indicates that the product conforms to regulations set out by the EC Directive.

Measurement categories

This instrument complies with CAT IV (600 V) safety requirements. To ensure safe operation of measurement instruments, IEC 61010 establishes safety standards for various electrical environments, categorized as CAT II to CAT IV, and called measurement categories. These are defined as follows.

CAT II: Primary electrical circuits in equipment connected to an AC electrical outlet by a power cord (portable tools, household appliances, etc.)

CAT III: Primary electrical circuits of heavy equipment (fixed installations) connected directly to the distribution panel, and feeders from the distribution panel to outlets.

CAT IV: The circuit from the service drop to the service entrance, and to the power meter and primary overcurrent protection device (distribution panel).

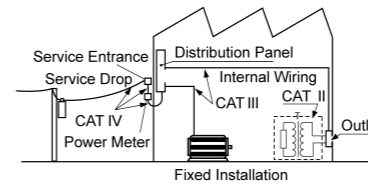

Using a measurement instrument in an environment designated with a higher-numbered category than that for which the instrument is rated could result in a severe accident, and must be carefully avoided. Use of a measurement instrument that is not CAT-rated in CAT II to CAT IV measurement applications could result in a severe accident, and must be carefully avoided.

Usage Notes



Follow these precautions to ensure safe operation and to obtain the full benefits of the various functions.

⚠ WARNING

This instrument is measured on a live line. To avoid electric shock when measuring live lines, wear appropriate protective gear, such as insulated rubber gloves, boots and a safety helmet.

⚠ CAUTION

- This instrument is designed for use indoors. It can be operated at temperatures between 0°C and 40°C without degrading safety.
- This instrument is not designed to be entirely water- or dust-proof. Do not use it in an especially dusty environment, nor where it might be splashed with liquid. This may cause damage.
- To avoid damage to the instrument, protect it from physical shock when transporting and handling. Be especially careful to avoid physical shock from dropping.
- Do not look directly into the penlight nor shine the light at another person's eye. Doing so may cause damage to the eye.

Measuring Principal

The static-induction voltage detection method using static coupling lets you verify the hot-line state of a wire.

Operating voltage range	40 V to 600 V AC (When placed into contact with a 2 mm ² insulated wire equivalent to 600 V polyvinyl chloride insulated wires) Maximum sensitivity adjustable range: 4 V to 80 V The operating voltage indicates a line-to-earth voltage of the grounded circuit.
Operating frequency range	50 Hz/ 60 Hz

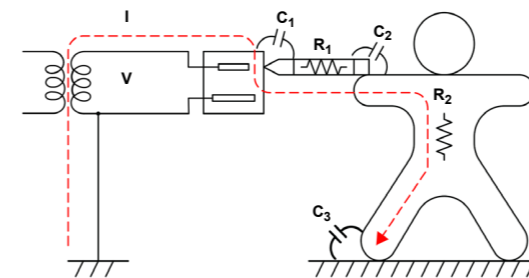

Measuring principle diagram

* Although a detected current will flow to the ground through your body, the current, which is less than 1 μA, will not adversely affect you.

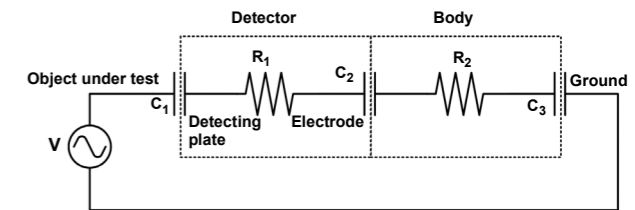

Equivalent circuit diagram

Examples of inapplicable circuits

Inapplicable circuit	Example	Cause
Grounded wire	<ul style="list-style-type: none"> • Grounding phase of single-phase circuit • Grounding phase of 3-phase circuit • Grounded neutral wire • Grounding wire 	Voltage is less than operating voltage range.
Shielded wire	shielded wire	Shield layer prevents signal from being detected.
Non-grounded power system	<ul style="list-style-type: none"> • Floating circuit • Transformer used in non-grounded circuit 	Line-to-earth voltage is unstable.
DC power system	<ul style="list-style-type: none"> • Battery-operated circuit • PV panel 	Static coupling point cannot flow DC.

NOTE

Even if you place the instrument into contact with an inapplicable circuit, the instrument may detect AC voltage of adjacent cables/wires, being activated.

Check a voltage using a voltmeter when in doubt.

Detection

Performance Check and Voltage Detection

⚠ DANGER

The maximum rated voltage between input terminals and ground is 600 V AC. Attempting to measure voltages exceeding 600 V with respect to ground could damage the instrument and result in personal injury.

NOTE

- The white LED indicates battery consumption but is not a guarantee of the performance of the instrument. Be sure to check its performance using a known power source (e.g., AC outlet) prior to use.
- The instrument voltage detector works using a live AC circuit. It will not work using an earthed wire or neutral point. If there are several lines, such as 2-phase wires and 3-phase wires, perform voltage detection on each line separately.
- The instrument cannot perform voltage detection on a shielded wire. (See the below figure.)

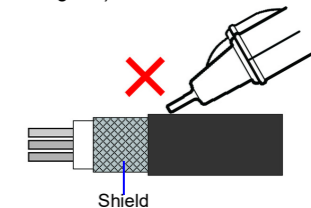

- Be sure to grip the instrument firmly during measurement. But, do not touch the portion beyond the barrier. It will not produce any detection.
- Make sure the detecting element properly contacts the object to be measured. (See the below figure.)

✗ Voltage detection is not performed properly.

○ Position the detecting element so that it is parallel to the object.



Performance Check

Be sure to check the following before and after use to avoid electrical shock.

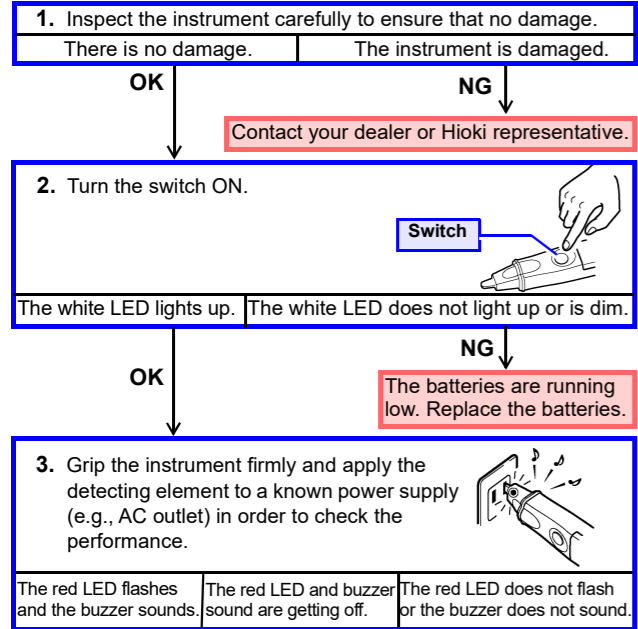

Detection

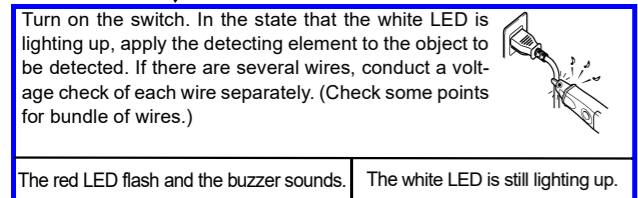

VOLTAGE DETECTOR	Object to be Measured
The white LED still lighting up, and the red LED flashes and the buzzer sounds.	Live.
Only the white LED lights up.	Not live or below the Operating-voltage range.

Adjusting sensitivity

- Slide the battery cover to the position where the sensitivity adjustment trimmer appears.
- Turn the trimmer with a precision screwdriver to adjust the sensitivity, placing the detecting element into contact with an object to be detected.

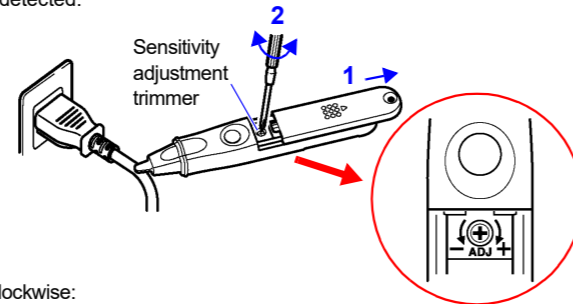

Clockwise:
Increase the sensitivity to detect a relatively low voltage.
Counterclockwise:
Decrease the sensitivity to detect a relatively high voltage

NOTE

The sensitivity will vary according to wire types or operating environments. Please adjust the sensitivity appropriately depending on your operating environment.

Replacing the batteries

WARNING

- Do not mix old and new batteries, or different types of batteries. Also, be careful to observe battery polarity during installation. Otherwise, poor performance or damage from battery leakage could result.
- Battery may explode if mistreated. Do not short-circuit, recharge, disassemble or dispose of in fire.
- Handle and dispose of batteries in accordance with local regulations.
- Keep batteries away from children to prevent accidental swallowing.

NOTE

- Use LR44 button alkaline battery.
- After use, always turn OFF the power to prevent battery drain.

Replacing the batteries

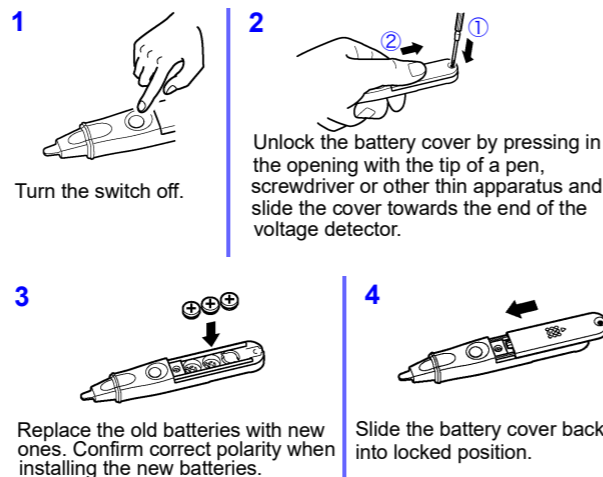

Name of Parts

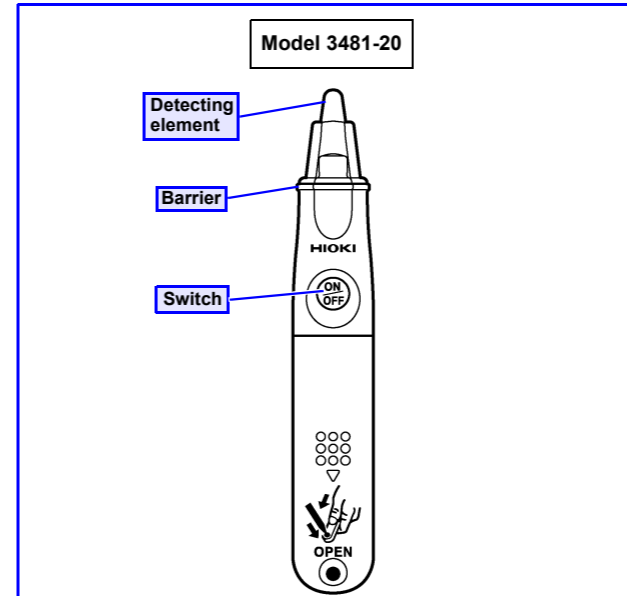

Specifications

Basic Specifications

Function	Detection
Operating Voltage Range	40V to 600 V AC (When brought into contact with a 2-mm ² insulated cable equivalent to 600 V polyvinyl chloride insulated wire) Maximum sensitivity variable range 40 V to 80 V AC
Operating frequency	50 Hz/60 Hz
Pilot light	The red LED flashes and the buzzer sounds when the wire is live.
Additional Functions	Light Battery check (The white LED is dim or out when the batteries are low.)
Power supply	Three LR44 button alkaline batteries.
Dimensions	Approx. 20W× 126H × 15D mm (0.79"W × 4.96"H × 0.59"D)(excluding projections)
Mass	Approx. 30 g (1.1 oz.) (including three LR44 button alkaline batteries)
Operating environment	Indoors, altitude up to 2000 m (6562 ft.)
Operating temperature and humidity	0°C to 40°C (32°F to 104°F), 80% RH or less. (no condensation)
Storage temperature and humidity	-20°C to 60°C (-4°F to 140°F), 80% RH or less. (no condensation)
Product warranty period	3 years
Accessories	Instruction manual Three LR44 button alkaline batteries (Installed in the instrument, for operation check)
Standards	Safety EN61010, Pollution degree2, Measurement category IV 600 V (anticipated transient overvoltage 8000 V) EMC EN61326

Electrical Specifications

Maximum rated voltage to earth	600 V AC
Dielectric strength	8.54 kV rms(between the detecting element and main body)
Rated supply voltage	1.5 V DC × 3
Operating supply-voltage range	From 4.95 V to the voltage at which the white LED goes out (central value: 3.6 V)

Maximum rated power	550 mVA (Max.)
Continuous operating time	Approx.5 hours (Power ON Standby state)
Auto power off	The power will be turned off automatically if the instrument remains idle for 3 minutes after the power is turned on. To reset, turn the power on again using the Power ON switch.

If a malfunction is suspected

Although the following phenomena, which are unavoidable in the detection principle, can be observed, the instrument has no malfunction.

Phenomenon	Cause
Even after the sensitivity adjustment or at a distance of tens of millimeters from circuits, the instrument detects the live circuits with a voltage of 200 V AC or higher.	Model 3481-20 is intended mainly to detect circuits with a voltage of 100 V AC. The sensitivity variable range is specified as from 40 V to 80 V AC in consideration of safety. Thus, the instrument may detect circuits with a voltage of 200 V AC or higher even after the sensitivity adjustment or at a distance from the circuit.
The instrument incorrectly detects metalware including steel desks as live.	Metalware close to AC power may charge AC potential (induced potential) to ground due to the influence of electrostatic capacitance, resulting in incorrectly detecting.
If the instrument is rapidly moved closer to or away from non-live circuits or DC circuits, the instrument detects live state temporarily.	The non-live circuits or DC circuits may charge static electricity, temporarily resulting in incorrectly detecting.

Warranty Certificate

HIOKI

Model	Serial number	Warranty period
		Three (3) years from date of purchase (___ / ___)
Customer name: _____		
Customer address: _____		
Important		
<ul style="list-style-type: none"> Please retain this warranty certificate. Duplicates cannot be reissued. Complete the certificate with the model number, serial number, and date of purchase, along with your name and address. The personal information you provide on this form will only be used to provide repair service and information about Hioki products and services. 		
This document certifies that the product has been inspected and verified to conform to Hioki's standards. Please contact the place of purchase in the event of a malfunction and provide this document, in which case Hioki will repair or replace the product subject to the warranty terms described below.		
Warranty terms		
1. The product is guaranteed to operate properly during the warranty period (three [3] years from the date of purchase). If the date of purchase is unknown, the warranty period is defined as three (3) years from the date (month and year) of manufacture (as indicated by the first four digits of the serial number in Y'YMM format). 2. If the product came with an AC adapter, the adapter is warranted for one (1) year from the date of purchase. 3. The accuracy of measured values and other data generated by the product is guaranteed as described in the product specifications. 4. In the event that the product or AC adapter malfunctions during its respective warranty period due to a defect of workmanship or materials, Hioki will repair or replace the product or AC adapter free of charge. 5. The following malfunctions and issues are not covered by the warranty and as such are not subject to free repair or replacement: <ul style="list-style-type: none"> -1. Malfunctions or damage of consumables, parts with a defined service life, etc. -2. Malfunctions or damage of connectors, cables, etc. -3. Malfunctions or damage caused by shipment, dropping, relocation, etc., after purchase of the product -4. Malfunctions or damage caused by inappropriate handling that violates information found in the instruction manual or on precautionary labeling on the product itself -5. Malfunctions or damage caused by a failure to perform maintenance or inspections as required by law or recommended in the instruction manual -6. Malfunctions or damage caused by fire, storms or flooding, earthquakes, lightning, power anomalies (involving voltage, frequency, etc.), war or unrest, contamination with radiation, or other acts of God -7. Damage that is limited to the product's appearance (cosmetic blemishes, deformation of enclosure shape, fading of color, etc.) -8. Other malfunctions or damage for which Hioki is not responsible 6. The warranty will be considered invalidated in the following circumstances, in which case Hioki will be unable to perform service such as repair or calibration: <ul style="list-style-type: none"> -1. If the product has been repaired or modified by a company, entity, or individual other than Hioki -2. If the product has been embedded in another piece of equipment for use in a special application (aerospace, nuclear power, medical use, vehicle control, etc.) without Hioki's having received prior notice 7. If you experience a loss caused by use of the product and Hioki determines that it is responsible for the underlying issue, Hioki will provide compensation in an amount not to exceed the purchase price, with the following exceptions: <ul style="list-style-type: none"> -1. Secondary damage arising from damage to a measured device or component that was caused by use of the product -2. Damage arising from measurement results provided by the product -3. Damage to a device other than the product that was sustained when connecting the device to the product (including via network connections) 8. Hioki reserves the right to decline to perform repair, calibration, or other service for products for which a certain amount of time has passed since their manufacture, products whose parts have been discontinued, and products that cannot be repaired due to unforeseen circumstances.		
HIOKI E.E. CORPORATION		18-07 EN-3
http://www.hioki.com		