

Handy and Easy to Use – Power Management Support



Now with
QUICK SET
Convenience

Harmonic Measurement Model
PW3360-21

Reliable measurements start with proper wiring.

The **QUICK SET** function guides you in making the right connections.

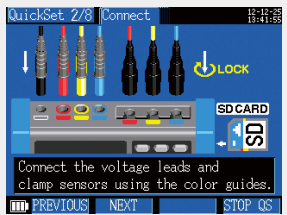

- See demand and trend graphs on site
- Supports single to three-phase, 4-wire circuits
 - Simultaneously measure up to three single-phase, 2-wire circuits (in the same power system).
- Measure up to 780V with a 1000V display range
- Broadly applicable for many jobs, including leakage current measurement
 - An optional clamp-on leakage sensor supports measurements as low as 50 mA.
- Store months of data on SD cards

Begin with QUICK SET Convenience

Select your Wiring Type, Clamp and Destination, and Connect

Select wiring type (example: 3P4W) and connect

1 Connect the leads to the PW3360-20.

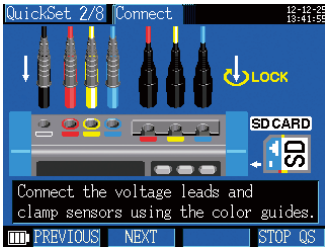

Make proper connections simply by observing the colors of the displayed leads.

2 Connect the voltage clips.

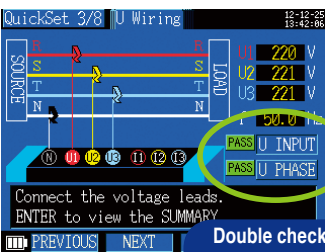

Proceed to the next step when PASS appears.

Check wire connection status and judgment indicators.

FAIL

If FAIL appears, move the cursor to the indicator and press the [ENTER] key.

3 Connect the clamp sensors.

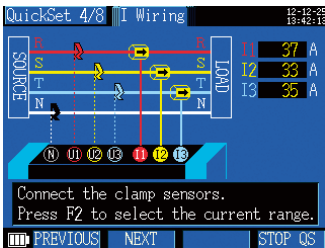

Corrective action tips appear

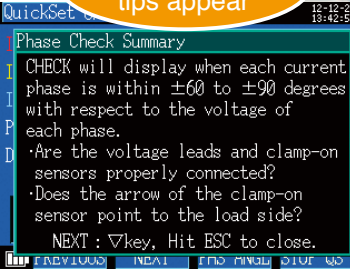

Miswiring Example (Clamp Orientation)

Correct Orientation

Power supply side



Point the arrow toward the load side

Affected measurement values:

Examples: P (Power) displayed value is too low **P: 6.5kW**

Wiring Screen Display Examples

FAIL

The I vector's phase direction is opposite the determination area.



PASS

The I vector's phase direction is within the determination area.



Changed **I3** Clamp

P: 20.6kW

Reveal Power Consumption State! Graph Display Functions

Demand Graph Display

Shows the demand value transitions useful for managing power consumption. Check maximum demand values and times while recording.

Read values at cursor

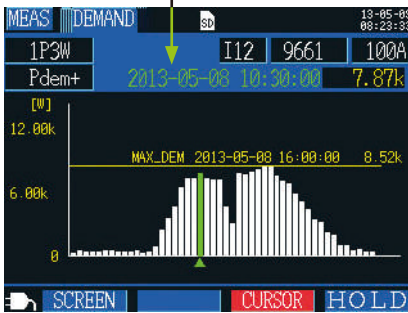

Maximum Demand Values

Automatically refreshes with latest values

One-day graph showing 48 thirty-minute intervals

Evaluate Photovoltaic Generation Capabilities

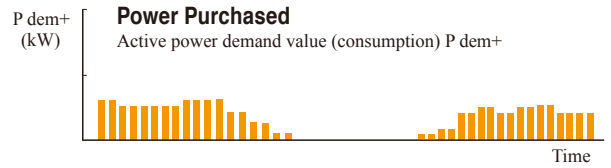

Switched Display



Trend Graph Display

From all measurement items, select one for display. Check states such as power fluctuations of devices in on-site operating conditions.

* Except for demand and harmonics

Read values at cursor

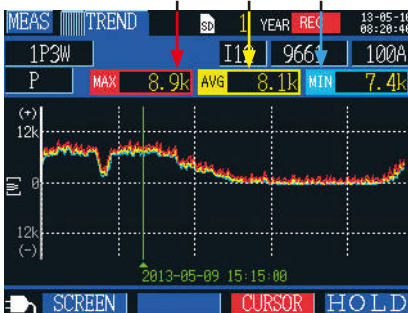

Of the interval time
Maximum Value
Average Value
Minimum Value
Graph Display

Automatically refreshes with latest values

Graph showing intervals of up to 200 points

Capture and record all fluctuations

To conveniently record fluctuations even over long periods, select "All" saving items to record maximum, minimum and average values within each recording interval.

Continuous calculation at 200 ms intervals without gaps

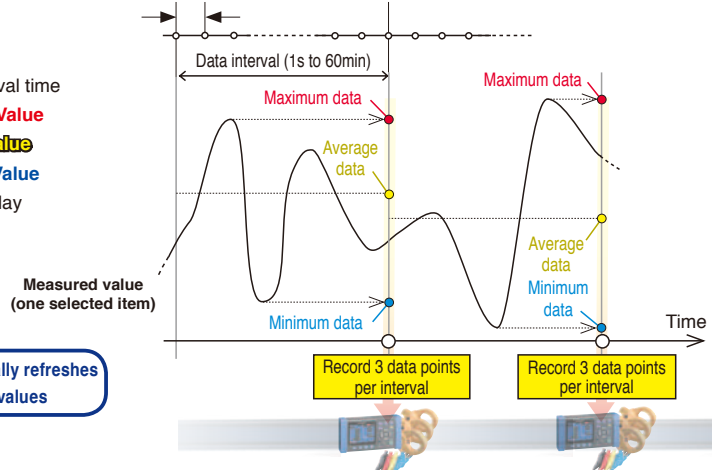

Create a Graph to Clearly Grasp Power Consumption



Record power consumption on an SD Card* at specific intervals. Load the data into the PC.

Use Excel graph processing for before and after comparisons.

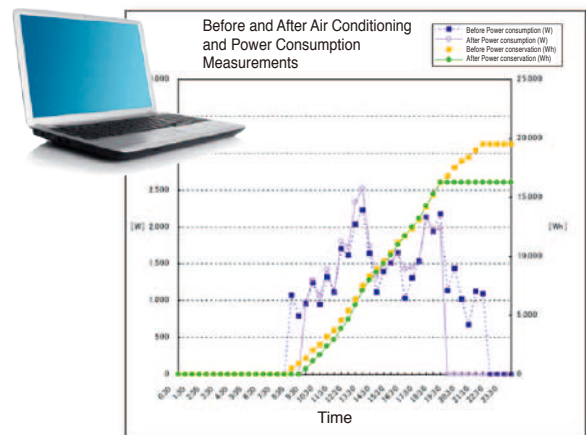
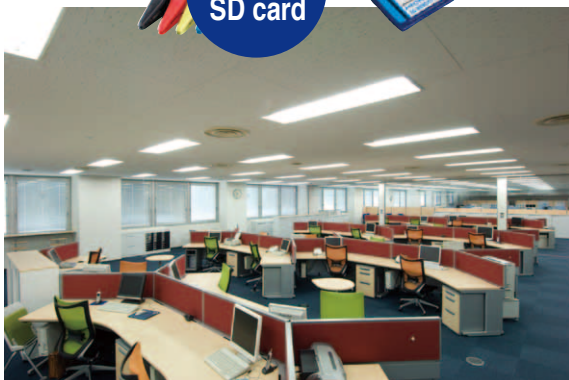

* Store up to one year's data acquired at one minute intervals. Performance cannot be guaranteed on storage media other than Hioki-specified SD card options.

Accommodates All Worksites

Tight spaces



Compact

**In dim environments
Easy-to-see color LCD**



180 mm (7.09")

Easy to loop around,
even in confined spaces



AC FLEXIBLE CURRENT SENSOR
CT9667-01, -02 (Sold separately)

Where no AC power is available

Battery* power provides about eight hours of continuous operation. In addition, a Voltage Line Power Adapter* is available to power the PW3360-20 from the measurement lines.

* Battery Set PW9002 and Voltage Line Power Adapter PW9003 options are sold separately.



Voltage Line
Power Adapter



Battery Set PW9002

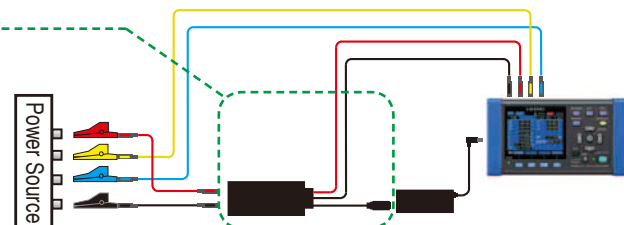

Obtains power from the measurement lines

In severe temperature environments

The operating temperature range extends from -10°C (14°F) to 50°C (122°F).

Even under battery operation, measurements can be performed from 0°C (32°F) to 40°C (104°F) (0°C (32°F) to 50°C (122°F) when using LAN communication).

50°C



-10°C



Magnetic voltage adapters for hard-to-clip terminals

Magnetic voltage adapters convertible with the Voltage Cords L9438-53 let you accurately detect voltage when the circuit terminals are too shallow for alligator clips to latch on.

* Magnetic Adapter 9804 option sold separately.

9804-01 Magnetic Adapter (red) usage example



Magnet in the tip

Generally compatible with M6 pan screws

Loaded with More Useful Functions

Simultaneous Measurements

Simultaneously measures three single-phase 2-wire circuits in the same system.

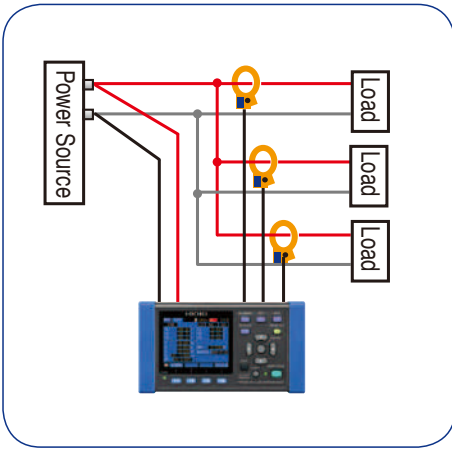

Pulse Input

The pulse input function can be used to record power data and production volume counts simultaneously. The power data and pulse volume (production volume) information are useful for unit cost production management.

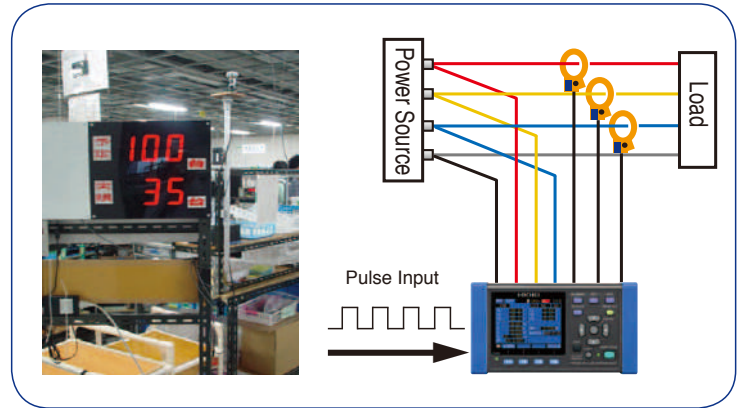

Pulse Output

Use the Pulse Output function to acquire temperature and pulse (electrical energy) data simultaneously with a data logger. Evaluate the relationship between air conditioner temperature control settings and power consumption.

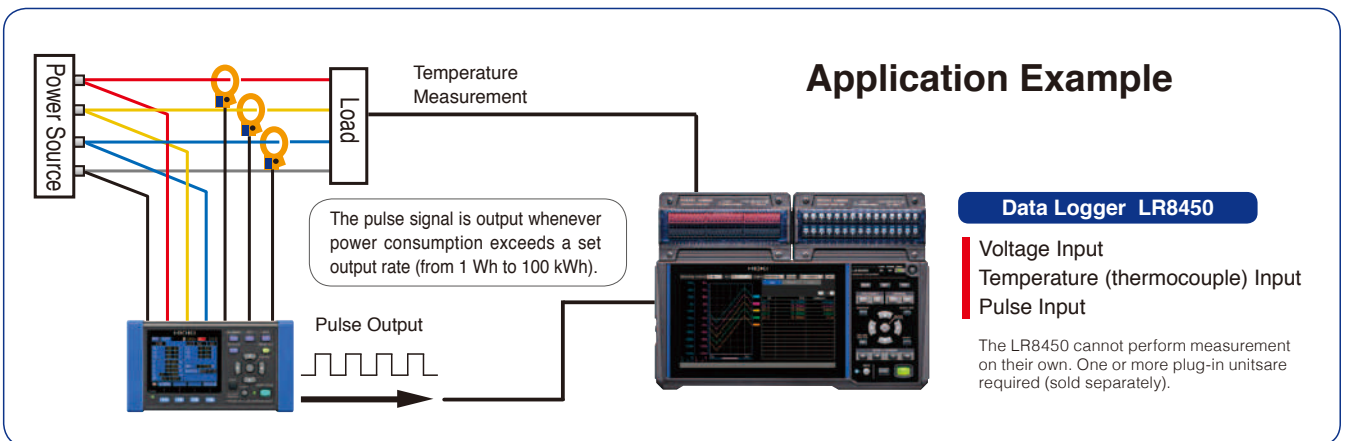

Leakage Current Measurement

With the optional leakage current clamp on sensors, turn the instrument into a 3-channel leakage current logger to help identify trouble spots.

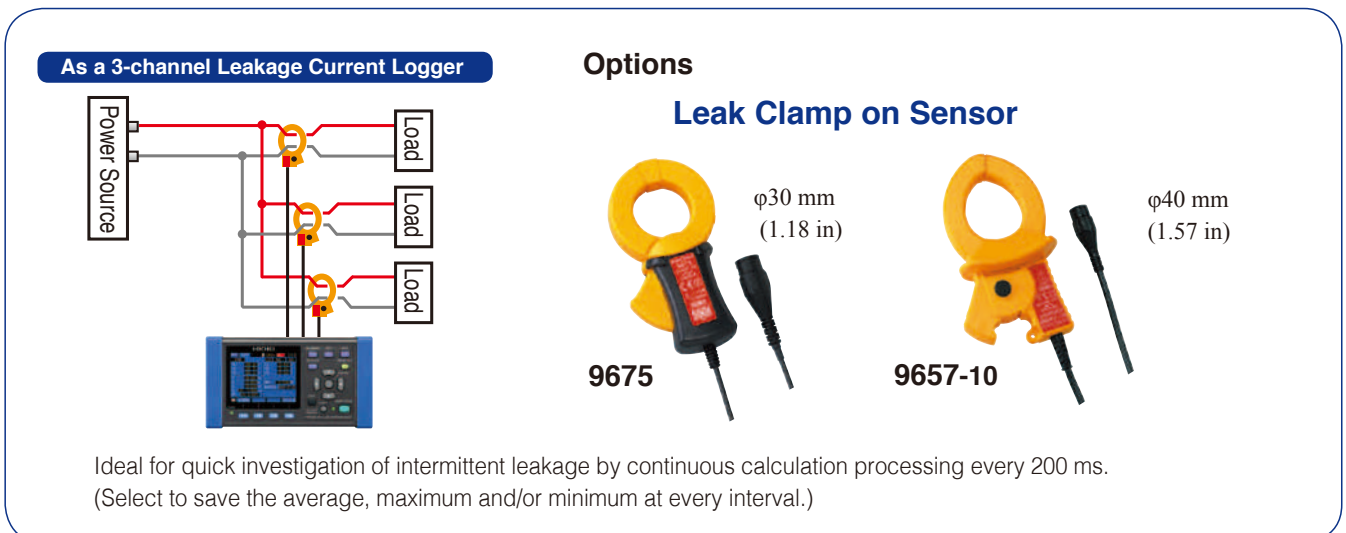

Harmonic Measurement Model

PW3360-21



Maximum, average, and minimum values can be saved in binary format to SD card at each interval.

Analyze voltage and current harmonics on a 50/60 Hz power line from the fundamental waveform to the 40th order.

- Displays the RMS value, content, and phase angle (numerical list or graph display) for each harmonic order.
- Vector display of power phase angle

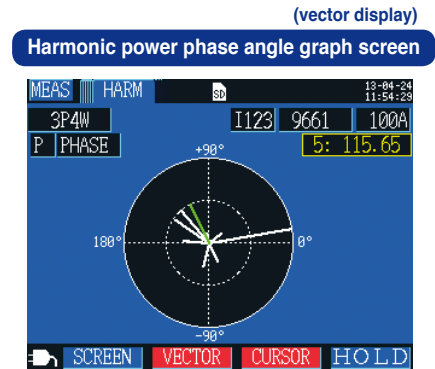
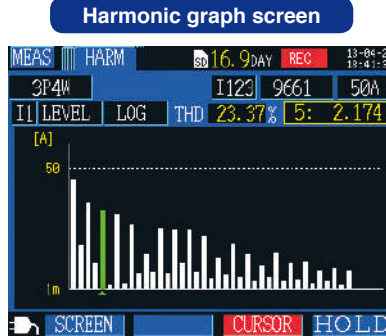

Power Logger Viewer SF1001 is required to display the data on a PC.



SF1001 Display Example Harmonic Time Series Display

Select and display a time series graph of fundamental, third- and fifth-order current harmonics.

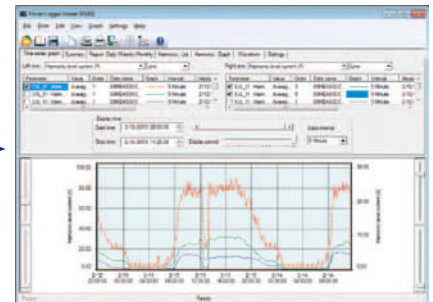

Power Logger Viewer SF1001 (option, sold separately)

Data saved to an SD card or internal memory can be loaded into a PC for expanded display, aggregation and analysis.

Supported models: PW3360, PW3365, 3169-20

On the same time axis, view measured power consumption and equipment operating status at specific intervals, along with equipment characteristics and management details.

- Trend graph display function
- Summary display function
- Waveform display
- Harmonic display
- Copy function
- Print function
- Report printing

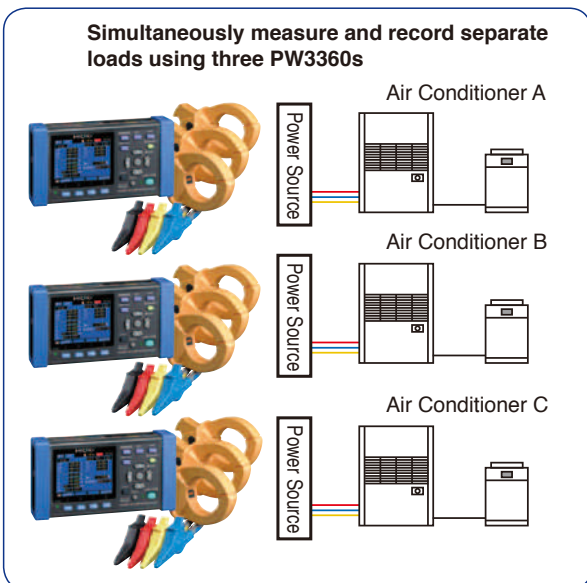

Stacked Graph Display Example

Maximum Demand Values

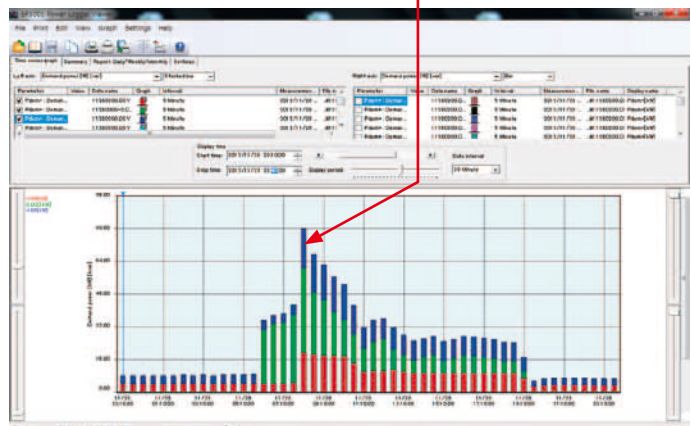

Get results from the job site in real-time

Present data from multiple sources as a graph or list together in real-time



PC Application Program

GENNECT One

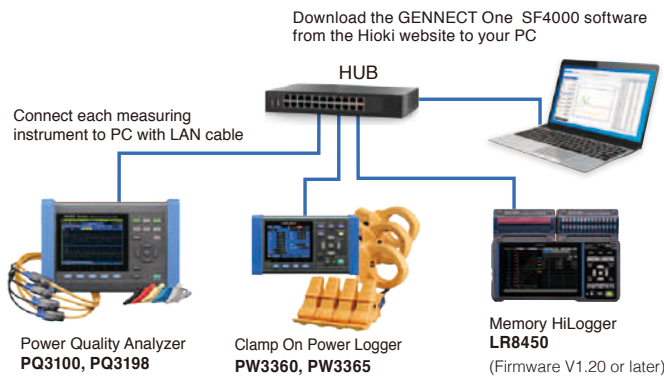

Simultaneously monitor all data in real-time

- Connect measuring instruments to PC with LAN cable
Operation guaranteed for up to 15 units. Please contact your nearest Hioki distributor for connections exceeding 15.
- Software automatically recognizes LAN-connected measuring instrument
- Display acquired data as graphs in real-time
The measured value (present value) displayed by the measuring instrument is obtained at a certain interval (minimum 1s interval) according to the timer on the PC.
- Operate measuring instruments connected via LAN from a PC
- Automatically transfer files saved on a LAN-connected measuring instrument to a PC
- Manage and save results with software
- List MAX, MIN and AVG values (Display time of MAX & MIN data)

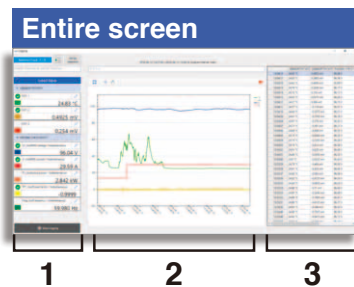

- 1. Monitor display (Max 512 items)**
Display each measured data in real-time
- 2. Graph display (Max 32 items)**
Display selected data as graphs
- 3. List display (Max 32 items)**
Display selected data in list

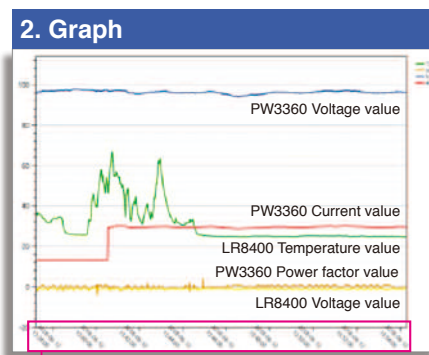
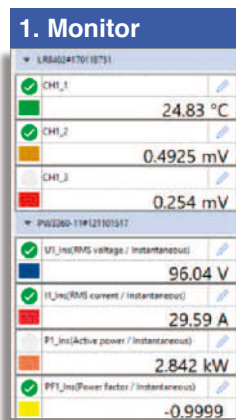

logging time (display up to 1024 points)

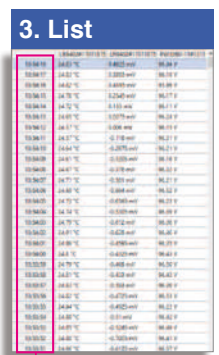

LAN remote control function

The application displays a virtual instrument and allows you to control it directly with the mouse. You can also easily change instrument settings and control the instrument, for example to start and stop measurement.

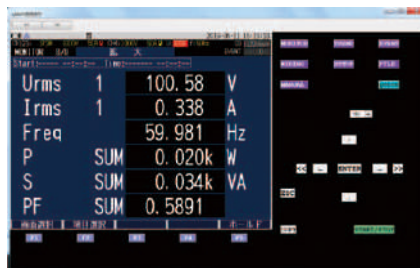

LAN automatic file download function

This function lets you acquire data in real time on a PC, including data created when the instrument's trigger is activated and measurement files that are automatically generated on a daily basis. Example uses include capturing abnormal phenomena with an instrument installed in the field and automatically acquiring daily power consumption data on a PC.

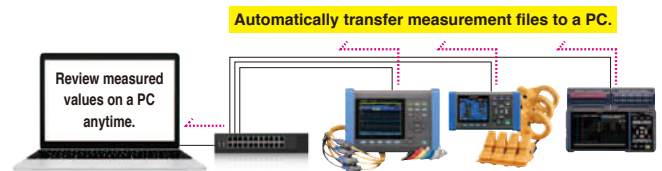

Downloading GENNECT One SF4000

HIOKI website > Search

Model No. (Order code)

SF4000

Search

Enter the model number in the search field to download the software to get started!

Compatible instruments	Available items to monitor and save on PC		Number of items that can be saved	Recording time
POWER QUALITY ANALYZER PQ3100, PQ3198	Voltage Current Power	Instantaneous value of each interval; MAX, MIN, AVG value of each interval	Save up to 512 items *Maximum 32 items when simultaneously displaying graphs	When memory size of acquired data reaches to 64MB, data will be separated automatically [Continuous measurement] When storage capacity falls below 512MB, measurement will stop
CLAMP ON POWER LOGGER PW3360, PW3365				
POWER ANALYZER PW3390, PW6001				
MEMORY HILOGGER LR8450, LR8450-01	Temperature Analog Input	Instantaneous value of each interval		
WIRELESS LOGGING STATION LR8410				
MEMORY HiCORDER MR6000				

PW3360-20, PW3360-21 Specifications

Specifications in orange available in Model PW3360-21 only

(Accuracy guaranteed for 1 year, Post-adjustment accuracy guaranteed for 1 year)

Input specifications	
Measurement line type	Single-phase 2-wire, single-phase 3-wire, three-phase 3-wire, three-phase 4-wire
Measurement line Frequency	50/ 60 Hz
Number of input channels	Voltage: 3 channels U1 to U3 Current: 3 channels I1 to I3
Voltage range	600 V AC Total display area: 5V to 1000 V (less than 5 V displays as 0 V) When RMS voltage is zero, zero is displayed for all orders of harmonic voltage. Effective measurement range: 90 V to 780 V, peak: $\pm 1400V$ [OVER] indicates over-range warning
Current ranges	Load current CLAMP ON SENSOR 9694 : 500 m/1/5/10/50 A CLAMP ON SENSOR 9695-02 : 500 m/1/5/10/50 A CLAMP ON SENSOR 9660 : 5/10/50/100 A CLAMP ON SENSOR 9695-03 : 5/10/50/100 A CLAMP ON SENSOR 9661 : 5/10/50/100/500 A CLAMP ON SENSOR 9669 : 100/200/1 k A AC FLEXIBLE CURRENT SENSOR CT9667-01 : 50/100 /500/1 k/5 kA AC FLEXIBLE CURRENT SENSOR CT9667-02 : 50/100 /500/1 k/5 kA AC FLEXIBLE CURRENT SENSOR CT9667-03 : 50/100 /500/1 k/5 kA Leakage current LEAK CLAMP ON SENSOR 9657-10 : 50 m/100 m/500 m/1/5 A LEAK CLAMP ON SENSOR 9675 : 50 m/100 m/500 m/1/5 A Total display range: Within 0.4 to 130% of the range (zero is suppressed for less than 0.4%) When RMS current is zero, zero is displayed for all orders of harmonic current. Effective measurement range: Within 5 to 110% of the range peak: $\pm 400\%$ of range, however, maximum range is 200%. [OVER] indicates over-range warning
Power ranges	300.00 W to 9.0000 MW Depends on voltage/current combination and measured line type (see Measurement Range Configuration Tables) Total display range: Within 0 to 130% of the range ("0W" display indicates zero rms voltage and/or current) When RMS voltage and current are zero, zero is displayed for all orders of harmonic active power and harmonic reactive power. Effective measurement area: Within 5 to 110% of the range
VT ratio settings	Any (0.01 to 9999.99) Selections (1/60/100/200/300/600/700/1000/2000/2500/5000)
CT ratio settings	Any (0.01 to 9999.99) Selections (1/40/60/80/120/160/200/240/300/400/600/800/1200)
Input methods	Voltage: Insolated inputs (except between U1, U2, U3 and N) Current: Isolated input using a clamp-on sensor
Input resistance	Voltage input part: $3 M\Omega \pm 20\%$ (50/ 60 Hz)
Maximum rated voltage between terminals	Voltage input section: 1000 VAC, 1400 Vpeak Current input section: 1.7 VAC, 2.4 Vpeak
Maximum rated voltage to earth	Voltage input section: 600V Measurement Category III 300V Measurement Category IV Current input section: Depends on clamp sensor in use.
Pulse input	
Input specifications	No-voltage contact input (counts when shorted terminals open) Voltage input (Hi: 2 V to 45 V, Lo: 0 V to 0.5 V, counts at Lo to Hi) Maximum rated input between terminals: 45 V DC Maximum rated input to ground: not isolated (GND is equipment common)
Measurement range	0 to 9999 (maximum pulse count per save interval)
Filter	Filter On (for mechanical contacts) 25 Hz or less, and at least 20 ms Hi and Lo pulse width Filter Off (for solid-state contacts) 5 kHz or less, and at least 100 μs Hi and Lo pulse width
Scaling	Displays product of pulse count and scaling factor setting Setting ranges: 0.001 to 1.000, and 1.000 to 100.00

Measurement items	
Voltage	RMS value, fundamental wave value, waveform peak (absolute value), fundamental wave phase angle, frequency (1)
Current	RMS value, fundamental wave value, waveform peak (absolute value), fundamental wave phase angle
Power	Active power, reactive power (with lag/lead display), apparent power, power factor, (with lag/lead display) or displacement power factor (with lag/lead display), active energy (consumption, regeneration, regeneration), reactive energy (lag, lead) Energy cost display (per-kWh price \times power consumption)
Demand	Active power demand value (consumption, regeneration), reactive power demand value (lag, lead), active power demand quantity *(consumption, regeneration), reactive power demand quantity *(lag, lead), power factor demand value, pulse input * Only data output to SD card
Harmonic	Harmonic voltage, current, power level, content, phase angle Total harmonic distortion factor (THD-F or THD-R)

Measurement screen	
List	Voltage RMS value, current RMS value, frequency, total active power, total reactive power, apparent power, power factor or displacement power factor, active energy (consumption), elapsed time
U/I	Voltage RMS value, voltage fundamental wave value, voltage waveform peak, voltage fundamental wave phase angle, current RMS value, current fundamental wave value, current waveform peak, current fundamental wave phase angle
Power	Per-channel and total active power, apparent power, reactive power, power factor or displacement power factor
Integ	Active energy (consumption, regeneration), reactive energy (lag, lead), recording start time, recording stop time, elapsed time, energy cost
Demand	Active power demand value (consumption, regeneration), reactive power demand value (lag, lead), power factor demand value, or pulse input Displays the maximum active power demand value and the time at which it occurred (this information is not saved). (data from up to 48 intervals is internally stored, then refreshed oldest-first).
Harmonic	Graph (voltage, current and power levels, content percentage and phase angle) List (voltage, current and power levels, content percentage and phase angle)
Waveform	Displays voltage and current waveform, voltage and current RMS values, and frequency. With a 3P3W3M connection, displays the phase voltage waveform from the virtual neutral point.
Zoom	Enlarged view of 4 user-selected parameters
Trend	For one selected measurement item (except demand and harmonics), displays maximum, average and minimum values, with cursor calculations available (Note: with Trend display, there is no power-off backup function).

External interfaces Specifications	
SD card Interface	Settings data, measurement data, screen data, waveform data
LAN interface	100BASE-TX IEEE802.3 Compliance - HTTP server function - FTP server function
USB interface	USB Ver 2.0, Windows 10 (32/64bit)/ Windows 8 (32/64bit)/ Windows 7 (32/64bit) / Vista (32bit) /XP - When connected to a computer, the SD Card and internal memory are recognized as removable storage devices.

Pulse output	
Function	Output pulse rate is proportional to active power consumption (WP+) when measuring integral power consumption
Pulse rate	OFF/ 1 Wh/ 10 Wh/ 100 Wh/ 1 kWh/ 10 kWh/ 100 kWh/ 1000 kWh (Default: 1 kWh)
Pulse width	approx. 100 ms
Output signal	Open-collector 30 V, 5 mA max (photocoupler isolated) Active Low

Pulse input terminals

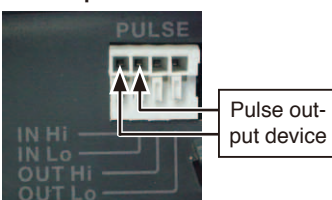

Pulse output terminals

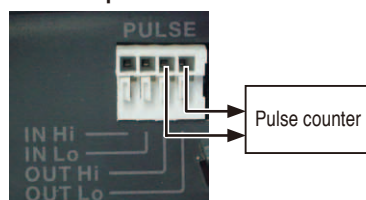

WIRE SPECIFICATIONS

Electric wires that conform with:

- single line: $\phi 0.65$ mm (AWG22)
- twisted wire: 0.32 mm² (AWG22)
- strand diameter: $\phi 0.12$ mm or more

Supported electric wires:

- single line: $\phi 0.32$ mm to $\phi 0.65$ mm (AWG28 to AWG22)
- twisted wire: 0.08 mm² to 0.32 mm² (AWG28 to AWG22)
- strand diameter: $\phi 0.12$ mm or more
- exposed wire length: 8 mm

General Specifications	
Display device	3.5 inch TFT color LCD (320 × 240 pixel) Japanese, English, Chinese, Korean, German, Italian, French, Spanish, Turkish Backlight auto-off function (after 2 minutes) When AUTO OFF is active, the Power LED blinks
Operating environment	Indoors, Pollution degree 2, altitude up to 2000 m (6562-ft.)
Operating temperature and humidity (no condensation)	-10°C to 50°C (14°F to 122°F), 80% RH or less During LAN communication: 0°C to 50°C (32°F to 122°F), 80% RH or less During battery operation: 0°C to 40°C (32°F to 104°F), 80% RH or less During battery charging: 10°C to 40°C (50°F to 104°F), 80% RH or less
Storage temperature and humidity (no condensation)	-20°C to 60°C (-4°F to 140°F), 80% RH or less However, the battery's storage temperature range is -20°C to 30°C (-4°F to 86°F), 80% RH or less
Dielectric strength	4.29 kVrms AC (1 mA sense current) between voltage input terminals and external terminals, 50/ 60 Hz for 60 sec.
Applicable standards	Safety: EN61010, EMC: EN61326, EN61000-3-2, EN61000-3-3
Power supply	•Z1006 AC Adapter (12 V, 1.25 A), Rated supply voltage 100 VAC to 240 VAC, Rated power supply frequency 50/60 Hz •Model 9459 Battery Pack (Ni-MH DC7.2 V 2700 mAh)
Charge function	Charges the battery regardless of whether the instrument is on or off. Charge time: Max. 6 hr. 10 min. (reference value at 23°C)
Maximum rated power	•When the Z1006 AC Adapter is used: 40 VA (including AC adapter), 13 VA (PW3360-20 instrument only) •When the 9459 Battery Pack is used: 3 VA
Continuous battery operation time	Approx. 8 hr. (Continuous, backlight off) (when using the battery pack)
Backup battery life	Clock and settings (Lithium battery), Approx. 10 years @23°C (@73.4°F)
Dimensions	Approx. 180W(7.09") × 100H(3.94") × 48D(1.89") mm (without PW9002) Approx. 180W(7.09") × 100H(3.94") × 68D(2.68") mm (with PW9002)
Mass	Approx. 550g (19.4 oz) (without PW9002), Approx. 830g (29.3 oz) (with PW9002)
Accessories	Voltage Cord L9438-53(1 set), AC Adapter Z1006 (1), USB cable(1), instruction manual (1), measurement guide (1), Color clip ×1 set: red, yellow, blue, white/two each, for color-coding clamp sensors, Spiral tubes for grouping clamp sensor cords ×5

(Accuracy guaranteed for 1 year, Post-adjustment accuracy guaranteed for 1 year)

Measurement Specifications	
Connection	Single-phase 2-wire (1P2W, 1P2W × 2 circuits, 1P2W × 3 circuits) Single-phase 3-wire (1P3W, 1P3W+I, 1P3W1U, 1P3W1U+I) Three-phase 3-wire (3P3W2M, 3P3W2M+I, 3P3W3M) Three-phase 4-wire (3P4W), Current only: 1 to 3 channels
Simultaneous power/current measurement modes	1P3W+I: 1 power circuit and 1 current channel 3P3W2M+I: 1 power circuit and 1 current channel
Calculation selection	Power factor, reactive and apparent power: rms calculation/ fundamental wave calculation
Measurement accuracy (50/ 60Hz, power factor = 1)	Voltage: ±0.3% rdg. ±0.1% f.s. Current: ±0.3% rdg. ±0.1% f.s. + clamp sensor accuracy Active power: ±0.3% rdg. ±0.1% f.s. + clamp sensor accuracy Clamp-On Sensor 9661 accuracy: ±0.3% rdg. ±0.01% f.s. (Accuracy depends on clamp sensor. See page 10 for the accuracy of each model, and page 11 for combined accuracy of Model PW3360-20 and each clamp sensor.)
Display update rate	Approx. 0.5 sec (except when accessing SD card or internal memory, or during LAN/USB communication) However, approx. 1 s for power-related values
Measurement method	Digital sampling and zero cross synchronization calculation method Sampling: 10.24 kHz (2048 points) Calculation processing 50 Hz: Continuous, gapless measurement at 10 cycles 60 Hz: Continuous, gapless measurement at 12 cycles
A/D converter resolution	16bit

Recording Specifications	
Save destination	SD Card, internal memory (capacity: approx. 320 KB)
Save interval time	1/2/5/10/15/30 seconds, 1/2/5/10/15/20/30/60 minutes * Available storage time is displayed on PW3360-20's setting screen
Save items	Measurement save: Average only / all (average, maximum, minimum) Harmonic data save: Binary format (average, maximum and minimum) Screen save: ON/OFF Saves the displayed screen as a BMP at a fixed interval. (The minimum interval time for saving screen copies is 5 min. If the setting is less than 5 min., screen copies will be saved every 5 min.) Waveform save: Stores binary waveform data (with shortest interval 1 minute). When set to less than 1 minute, waveforms are saved once every minute
Recording start methods	Interval time, manual, specified time, repeat: Record period(00:00 to 24:00) ·Segment folder(off/day/week/month)
Recording stop methods	Manual, specified time, timer, repeat (up to one year)

Specifications in orange available in Model PW3360-21 only

Harmonic Specifications (PW3360-21 only)	
Standard	IEC61000-4-7:2002 compliant, but without interharmonics
Window width	10 cycles at 50 Hz, and 12 cycles at 60 Hz (with interpolation)
Points per window	Rectangular, 2048 points
Analysis orders	Up to the 40th order
THD calculation selection	THD-F/THD-R
Analysis items	Harmonic level: Voltage, current and power levels for each harmonic (U12 and I12 obtained by calculation of the third channel in 3P3W2M wiring are not displayed. Phase voltage is used for 3P3W3M wiring.) Harmonic content: Voltage, current and power contents for each harmonic Harmonic phase angle: Voltage, current and power phase angles for each harmonic Total harmonic distortion factor: Voltage and current (THD-F or THD-R)
Measurement accuracy	Harmonic level 1st to 15th orders : ±5% rdg. ±0.2% f.s. 16th to 20th orders : ±10% rdg. ±0.2% f.s. 21st to 40th orders : ±20% rdg. ±0.3% f.s. For voltage and current, add accuracy of clamp sensor. Harmonic power phase angle 1st to 3rd orders : ±3°+clamp sensor accuracy 4th to 40th orders : ±0.1°×k±3°+clamp sensor accuracy For each harmonic order at 6 V, harmonic current level is regulated at 1% f.s. Total harmonic distortion factor: Accuracy unspecified

POWER LOGGER VIEWER SF1001 Specifications



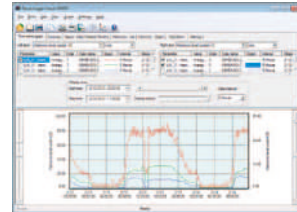

General Specifications	
Supported models	PW3360-20, PW3360-21, PW3365, 3169-20, 3169-21 LR5000 series; Data previously loaded by the LR5000 Utility (.hrp2 format) using a PC
Supported computer operating systems	Windows 8/8.1 (32/64bit), Windows 7 SP1 or later (32/64bit) Windows Vista SP2 or later (32bit), Windows XP SP3 or later (32bit)



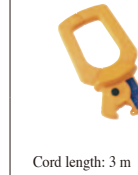
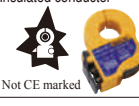

Functions Specifications	
Trend graph display function	Display items: Voltage, current, active power, reactive power, apparent power, power factor, frequency, integrated active power, integrated reactive power, demand volume, demand value, voltage disequilibrium factor, pulse, harmonics (level, content, phase angle, total value, THD) Stacked bar graph display: Up to 16 types of data series can be displayed in an overlay graph Cursor measurements: Measurement values can be displayed by the cursor
Summary display function	Displayed items are the same as for the trend Graph Display Daily, weekly and monthly report displays: Accumulates and displays daily, weekly and monthly reports over specified period. Load factor calculation display: Calculates and displays load factor and demand factor results with daily, weekly and monthly reports Time span aggregation: Aggregates data into up to four specified time spans CO2 equivalent display: Uses the specified conversion rate to display CO2 equivalent values (reference values).
Waveform display	Displays waveform data at specified date and time
Harmonic display	List display: Displays a list of harmonic data at specified date and time Graph display: Displays a bar graph of harmonic data at specified date and time Cursor calculation: Calculates measurement data at cursors in waveform and graph displays
Copy function	Captures any display image to the clipboard
Print function	Preview and print content shown on the trend graph, report, harmonic graph and settings displays. Comment entry (Text comments can be entered in any printout) Header/Footer settings: Sets the header and footer for each printout Printing support: Any color or monochrome printing supported by the operating system
Report printing	Print (static) contents over a specific time period Output contents: Standard or selected output items Available output items: Trend graph, summary, daily report, harmonic list, harmonic graph, waveform Report creation method: Standard print Report output settings: Save/load report output settings

CLAMP SENSOR Specifications

CLAMP ON SENSOR

		9694	9660	9661	9669	9695-02	9695-03
Appearance		 Cord length: 3 m (9.84ft)	 Cord length: 3 m (9.84ft)	 Cord length: 3 m (9.84ft)	 Cord length: 3 m (9.84ft)	 Insulated conductor Not CE marked	 Insulated conductor Not CE marked
Measurable conductor diameter		φ15 mm (0.59")	φ15 mm (0.59")	φ46 mm (0.81")	φ55 mm (2.17"), 80 (3.15")×20 (0.79") mm	φ15 mm (0.59")	φ15 mm (0.59")
Primary current rating		5 A AC	100 A AC	500 A AC	1000 A AC	50 A AC	100 A AC
Accuracy	Amplitude (45 to 66 Hz)	±0.3% rdg. ±0.02% f.s.	±0.3% rdg. ±0.02% f.s.	±0.3% rdg. ±0.01% f.s.	±1.0% rdg. ±0.01% f.s.	±0.3% rdg. ±0.02% f.s.	±0.3% rdg. ±0.02% f.s.
	Phase (45 Hz to 5 kHz)	Within ±2°	Within ±1°	Within ±0.5°	Within ±1°	Within ±2°	Within ±1°
Frequency characteristic 40Hz to 5kHz (deviation from accuracy)		Within ±1.0%			Within ±2.0%	Within ±1.0%	
Effect of external magnetic field (with a magnetic field of 400 A/m AC)		Equivalent to 0.1 A or less			Equivalent to 1 A or less	Equivalent to 0.1 A or less	
Effect of conductor position		Within ±0.5%			Within ±1.5%	Within ±0.5%	
Maximum rated voltage to earth		CAT III 300 Vrms	CAT III 300 Vrms	CAT III 600 Vrms	CAT III 600 Vrms	CAT III 300 Vrms	
Maximum input (45 to 66Hz)		50 A continuous	130 A continuous	550 A continuous	1000 A continuous	60 A continuous	130 A continuous
Dimensions		46W (1.81")×135H (5.31") ×21D (0.83") mm	46W (1.81")×135H (5.31") ×21D (0.83") mm	77W (3.03")×151H (5.94") ×42D (1.65") mm	99.5W (3.92")×188H (7.40") ×42D (1.65") mm	50.5W (2.28")×58H (2.28") ×18.7D (0.74") mm	
Mass		230 g (8.1 oz)	230 g (8.1 oz)	380 g (13.4 oz)	590 g (20.8 oz)	50 g (1.8 oz)	

AC FLEXIBLE CURRENT SENSOR

		CT9667-01	CT9667-02	CT9667-03
Appearance				
		Cord length : Sensor - circuit: 2 m (6.56ft) Circuit - connector: 1 m (3.28ft)		
Measurable conductor diameter		φ100 mm (3.94")	φ180 mm (7.09")	φ254 mm (10.00")
Primary current rating		500 A AC / 5000 A AC		
Accuracy (45 to 66Hz)	Amplitude	±2.0% rdg. ±0.3% f.s.		
	Phase	Within ±1°		
Frequency characteristic 10Hz to 20kHz (deviation from accuracy)		Within ±3 dB		
Effect of external magnetic field (with a magnetic field of 400 A/m AC)		1.5% / f.s. or less.		
Effect of conductor position		Within ±3.0%		
Maximum rated voltage to earth		CAT III 1000 Vrms, CAT IV 600 Vrms		
Maximum input (45 to 66Hz)		10000 A continuous		
Dimensions	Circuit box	35W (1.38")×120H (4.74")×34D (1.34") mm		
	Sensor cable diameter	φ7.4 mm (0.29")	φ13 mm (0.51")	
Mass		280 g (9.9 oz.)	470 g (16.6 oz.)	
Power supply		LR06 alkaline battery × 2 (continuous operation max. 7 days) or AC ADAPTER 9445-02/9445-03 (optional)		

CLAMP ON LEAK SENSOR (Leakage Current Measurement Only)

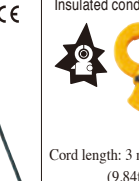
		9657-10	9675
Appearance		 Insulated conductor Cord length: 3 m (9.84ft)	 Insulated conductor Cord length: 3 m (9.84ft)
Measurable conductor diameter		φ40 mm (1.57")	φ30 mm (1.18")
Primary current rating		10 AAC*	10 AAC*
Accuracy	Amplitude (45 to 66 Hz)	±1.0% rdg. ±0.05% f.s.	±1.0% rdg. ±0.005% f.s.
	Phase angle (@50 or 60 Hz)	Within ±3°	Within ±5°
Frequency characteristic 40 Hz to 5 kHz (deviation from accuracy)		Within ±5%	Within ±5%
Effect of external magnetic field (with a magnetic field of 400 A/m AC)		7.5 mA max.	7.5 mA max.
Effect of conductor position		Within ±0.1%	Within ±0.1%
Measurable conductor		Insulated conductor	Insulated conductor
Maximum input (45 to 66Hz)		30 A continuous	10 A continuous
Dimensions		74W (2.91")×145H (5.71") ×42D (1.65")	60W (2.36")×112.5H (4.43") ×23.6D (0.95")
Mass		380 g (13.4 oz)	160 g (5.6 oz)
Notes		Not used for power measurements	

* Maximum AC measurement range with PW3360-20 is 5 A.

Available Recording Time

PW3360-20 and PW3360-21 with Z4001 2-GB SD card, measuring 3P3W2M wiring

Saved Items: ALL data (Saves all data: average, maximum, and minimum values)

Screen save: OFF Waveform save: OFF

Interval time	Save Time		Interval time	Save Time	
	PW3360-20 PW3360-21 (Saving of harmonic data: OFF)	PW3360-21 (Saving of harmonic data: ON)		PW3360-20 PW3360-21 (Saving of harmonic data: OFF)	PW3360-21 (Saving of harmonic data: ON)
1 seconds	15.9 days	24.7 hours	30s	1 year	30.8 days
2 seconds	31.9 days	2.1 days	1 minutes	1 year	61.7 days
5 seconds	79.7 days	5.1 days	2 minutes	1 year	123 days
10 seconds	159 days	10.3 days	5 minutes	1 year	308 days
15 seconds	242 days	15.4 days	More than 10 minutes	1 year	1 year

The maximum recording time based on the settings can be confirmed right on the Settings screen.

In any case, the maximum file size for measurement data is about 200 MB. When this is exceeded, a new file is created and saving continues.

<NOTE>

Regardless of the settings, the maximum save time of the PW3360-20, PW3360-21 is one year.

■ Measurement Range Configurations

Current		CLAMP ON SENSOR 9694 (CAT III 300 V) *1				
Voltage		CLAMP ON SENSOR 9695-02 (CAT III 300 V)				
Connection	500.00 mA	1.0000 A	5.0000 A	10.000 A	50.000 A	
600.00 V	1P2W	300.00 W	600.00 W	3.0000 kW	6.0000 kW	30.000 kW
	1P3W	600.00 W	1.2000 kW	6.0000 kW	12.000 kW	60.000 kW
	1P3W1U					
	3P3W2M					
	3P3W3M					
3P4W	900.00 W	1.8000 kW	9.0000 kW	18.000 kW	90.000 kW	

*1. For the 9694 sensor, the range of guaranteed accuracy is from 500 mA to 5 A, and for the 9695-02, from 500 mA to 50 A.

Current		CLAMP ON SENSOR 9660, 9695-03 (CAT III 300 V) *2				
Voltage		CLAMP ON SENSOR 9661				
Connection	5.0000 A	10.000 A	50.000 A	100.00 A	500.00 A	
600.00 V	1P2W	3.0000 kW	6.0000 kW	30.000 kW	60.000 kW	300.00 kW
	1P3W	6.0000 kW	12.000 kW	60.000 kW	120.00 kW	600.00 kW
	1P3W1U					
	3P3W2M					
	3P3W3M					
3P4W	9.0000 kW	18.000 kW	90.000 kW	180.00 kW	900.00 kW	

*2. For the 9660 and 9695-03 sensors, the range of guaranteed accuracy is from 5 A to 100 A, and for the 9661, from 5 A to 500 A.

Current		CLAMP ON SENSOR 9669		
Voltage		100.00 A	200.00 A	1.0000 kA
600.00 V	1P2W	60.000 kW	120.00 kW	600.00 kW
	1P3W	120.00 kW	240.00 kW	1.2000 MW
	1P3W1U			
	3P3W2M			
	3P3W3M			
3P4W	180.00 kW	360.00 kW	1.8000 MW	

Current		AC FLEXIBLE CURRENT SENSOR CT9667-01, -02, -03				
Voltage		500 A range		500/5000 A range	5000 A range	
Connection	50.000 A	100.00 A	500.00 A	1.0000 kA	5.0000 kA	
600.00V	1P2W	30.000 kW	60.000 kW	300.00 kW	600.00 kW	3.0000 MW
	1P3W	60.000 kW	120.00 kW	600.00 kW	1.2000 MW	6.0000 MW
	1P3W1U					
	3P3W2M					
	3P3W3M					
3P4W	90.000 kW	180.00 kW	900.00 kW	1.8000 MW	9.0000 MW	

Leak current: CLAMP ON LEAK SENSOR 9657-10, 9675	
Range	50.000 mA/100.00 mA/500.00 mA/1.0000 A/5.0000 A

■ Measurement accuracy

Voltage	±0.3% rdg. ±0.1% f.s.
Current	±0.3% rdg. ±0.1% f.s. + clamp sensor accuracy
Active power	±0.3% rdg. ±0.1% f.s. + clamp sensor accuracy (power factor = 1)

Combined accuracy of PW3360-20 + clamp sensors

Range	9694	9695-02
50.000 A	—	±0.6% rdg. ±0.12% f.s.
10.000 A	—	±0.6% rdg. ±0.2% f.s.
5.0000 A	±0.6% rdg. ±0.12% f.s.	±0.6% rdg. ±0.3% f.s.
1.0000 A	±0.6% rdg. ±0.2% f.s.	±0.6% rdg. ±1.1% f.s.
500.00 mA	±0.6% rdg. ±0.3% f.s.	±0.6% rdg. ±2.1% f.s.

Range	9660, 9695-03	9661
500.00 A	—	±0.6% rdg. ±0.11% f.s.
100.00 A	±0.6% rdg. ±0.12% f.s.	±0.6% rdg. ±0.15% f.s.
50.000 A	±0.6% rdg. ±0.14% f.s.	±0.6% rdg. ±0.2% f.s.
10.000 A	±0.6% rdg. ±0.3% f.s.	±0.6% rdg. ±0.6% f.s.
5.0000 A	±0.6% rdg. ±0.5% f.s.	±0.6% rdg. ±1.1% f.s.

Range	9669
1.0000 kA	±1.3% rdg. ±0.11% f.s.
200.00 A	±1.3% rdg. ±0.15% f.s.
100.00 A	±1.3% rdg. ±0.2% f.s.

Range	CT9667 ⁻⁰¹ ₋₀₂ 5000A range	CT9667 ⁻⁰¹ ₋₀₂ 500A range
5.0000kA	±2.3% rdg. ±0.4% f.s.	—
1.0000kA	±2.3% rdg. ±1.6% f.s.	—
500.00A	±2.3% rdg. ±3.1% f.s.	±2.3% rdg. ±0.4% f.s.
100.00A	—	±2.3% rdg. ±1.6% f.s.
50.000A	—	±2.3% rdg. ±3.1% f.s.

Total display range

Voltage is displayed from 5 V to 1000 V, with less than 5 V displayed as 0 V.

Current is displayed from 0.4% to 130% of the selected range, with less than 0.4% displayed as 0 A

Power is displayed from 0 to 130% of full scale, with 0 W displayed when voltage or current is zero.

The range configurations for apparent power (S) and reactive power (Q) are the same, with units of [VA] and [var], respectively.

When VT and CT ratios are set, the range configuration is the product (VT ratio × CT ratio).

Effective measurement range

For voltage, 90 to 780 V, with max. 1400 V peak.

For current, 5% to 110% of the selected range with peak ±400% of range, but maximum range is ±200%.

For power, 5% to 110% of the selected range.

For frequency, 45 to 66 Hz.

■ Current Display and Effective Measurement Ranges (typical)

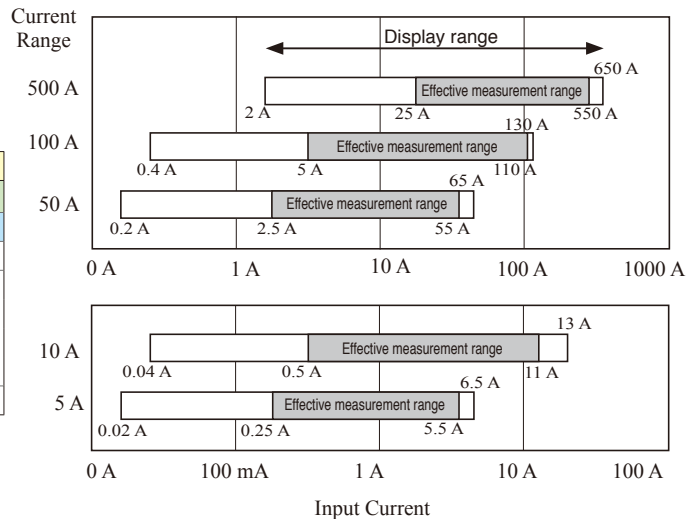

Conditions of guaranteed accuracy	After 30 minute warm-up, with 50/60 Hz sine wave input
Temperature and humidity for guaranteed accuracy	23°C ±5°C (73 ±9°F), 80%RH or less (applies to all specifications unless otherwise noted)
Display area of guaranteed accuracy	Effective measurement range

Real-time clock accuracy	Within ±0.3 sec/day (at power ON, 0°C to 50 °C) Within ±0.5 sec/day (at power ON, -10°C to 0 °C)
Temperature characteristic	Within ±0.1% f.s./°C (except 23 ±5°C)
Effect of common mode voltage	Within ±0.2% f.s. (600 V AC, 50/60 Hz, between voltage input terminal and case)
Effect of external magnetic field	Within ±1.5% f.s. (in a magnetic field of 400 A/m rms AC, 50/60 Hz)
Effect of phase	Phase accuracy ±1.3° equivalent (with 50/60 Hz f.s. input)

Apparent power	±1 dgt. for the calculation obtained from each measurement value
Reactive power	Fundamental waveform calculations ±0.3% rdg. ±0.1% f.s. + clamp-on sensor accuracy (w/power factor = 1) Rms calculations From each measurement applied to calculation ±1 dgt.
Energy	Active and reactive power measurement accuracies ±1 dgt.
Power factor	From each measurement applied to calculation ±1 dgt.
Frequency	±0.5% rdg. (with 90 to 780 V sine wave input)
Demand value	Active and reactive power measurement accuracies ±1 dgt.
Demand quantity	Active and reactive power measurement accuracies ±1 dgt.
Pulse input	±1 dgt. for the calculation obtained from each measurement value
Frequency characteristic	At 50/60 Hz fundamental waveform frequency, up to 1 kHz, ±3% rdg. ±0.2% f.s. up to 3kHz, ±10% rdg. ±0.2% f.s. For current and active power, add clamp-on sensor accuracy. Note: only for 3P3W3M wiring, add ±0.5% rdg.



Current sensors : Sold separately

Model : CLAMP ON POWER LOGGER PW3360

Model No. (Order Code) (Note)

- PW3360-20 (English model, main unit only)
- PW3360-21 (English model, with harmonic analysis function)

Accessories: Voltage cord L9438-53 ×1 set, AC adapter Z1006 ×1, USB cable ×1, Instruction manual ×1, Measurement guide ×1, Color clip ×1 set: red, yellow, blue, white/two each, for color-coding clamp sensors, Spiral tubes for grouping clamp sensor cords ×5

Note: At least one optional current sensor is necessary to measure current or power parameters. To store measurement data, use only the guaranteed SD cards sold by HIOKI.

Bundled Accessories

AC ADAPTER Z1006



100 to 240 V AC

VOLTAGE CORD L9438-53



cord length: 3m (9.84 ft)

1 cord each of black, red yellow, and blue, and five spiral tubes for bundling cords

Options

CLAMP ON SENSOR (for load current measurement)

- CLAMP ON SENSOR 9694 (5 A AC)
- CLAMP ON SENSOR 9660 (100 A AC)
- CLAMP ON SENSOR 9661 (500 A AC)
- CLAMP ON SENSOR 9669 (1000 A AC)
- AC FLEXIBLE CURRENT SENSOR CT9667-01 (5000 A AC)
- AC FLEXIBLE CURRENT SENSOR CT9667-02 (5000 A AC)
- AC FLEXIBLE CURRENT SENSOR CT9667-03 (5000 A AC)

- CLAMP ON SENSOR (Not CE marked) 9695-02 (50 A AC)
 - CLAMP ON SENSOR (Not CE marked) 9695-03 (100 A AC)
 - CONNECTION CORD 9219 (for connection to 9695-02, 9695-03)
- When purchasing the 9695-02 and 9695-03, we recommend also purchasing the separately sold 9219 Connection Cord.

CLAMP ON LEAK SENSOR (for leakage current measurement)

- CLAMP ON LEAK SENSOR 9657-10
- CLAMP ON LEAK SENSOR 9675

CLAMP ON ADAPTER

9290-10 MAX. 1500 A AC (continuous: 1000 A)

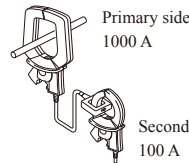

CAT III 600 V
Cord length: 3 m (9.84 ft)

Measurable conductor diameter

φ55 mm (2.17 in)
Bus bar: ■ 80 mm (3.46in) × 20 mm (0.79 in)
CT ratio: 10:1

PATCH CORD

L1021-01



Banana branch-banana, Red: 1, Cable length: 0.5 m, For branching from the L9438-50 or L1000, CAT IV 600 V, CAT III 1000 V

L1021-02



Banana branch-banana, Black: 1, Cable length: 0.5 m, For branching from the L9438-50 or L1000, CAT IV 600 V, CAT III 1000 V

Storage media

- SD MEMORY CARD 2GB Z4001
- SD MEMORY CARD 8GB Z4003



Stores up to one year's data when acquired at one minute intervals.

SD Card Precaution

Use only SD Cards sold by HIOKI. Compatibility and performance are not guaranteed for SD cards made by other manufacturers. You may be unable to read from or save data to such cards.

VOLTAGE LINE POWER ADAPTER

PW9003

(supplies power from measurement lines)

Rated voltage: 240 V AC

Operating temperature and humidity range: -10 to 50°C, 80% RH or less



CAT III 300V

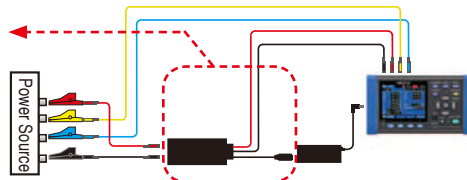

BATTERY SET

Battery Case and Battery Pack Set

PW9002



BATTERY PACK 9459

NiMH, Charges while installed in the main unit

CARRYING CASE

C1005



Dimension:
Approx. 390W (15.4") × 275H (10.8") × 110D (4.3") mm

MAGNET ADAPTER

9804-01 Red



9804-02 Black

φ11mm (0.43 in)
(generally compatible with M6 pan screws)

Magnetic tip for use with the standard VOLTAGE CORD L9438-53

Red and black adapters sold separately. Purchase the quantity and color appropriate for your application. (Example: 3P3W-3 adapters, 3P4W-4 adapters)

POWER LOGGER VIEWER

SF1001

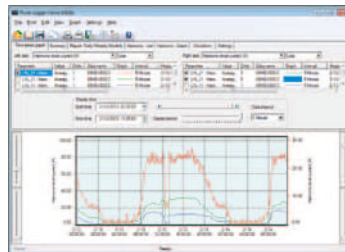

LAN CABLE

9642



Straight Ethernet cable, supplied with straight to cross conversion adapter, 5 m (16.41 ft) length

Note: Company names and product names appearing in this catalog are trademarks or registered trademarks of various companies.

HIOKI

HIOKI E. E. CORPORATION

HEADQUARTERS

81 Koizumi,
Ueda, Nagano 386-1192 Japan
<https://www.hioki.com/>



Scan for all regional contact information

DISTRIBUTED BY