



P/N: 110401109388X

UNI-T®



UT385 Laser Power Meter User Manual

Preface

Thank you for purchasing this brand new product. In order to use this product safely and correctly, please read this manual thoroughly, especially the safety notes.

After reading this manual, it is recommended to keep the manual at an easily accessible place, preferably close to the device, for future reference.

Limited Warranty and Liability

Uni-Trend guarantees that the product is free from any defect in material and workmanship within one year from the purchase date. This warranty does not apply to damages caused by accident, negligence, misuse, modification, contamination or improper handling. The dealer shall not be entitled to give any other warranty on behalf of Uni-Trend. If you need warranty service within the warranty period, please contact your seller directly.

Uni-Trend will not be responsible for any special, indirect, incidental or subsequent damage or loss caused by using this device.

Table of Contents

1. Introduction	2
2. Features	2
3. Accessories	2
4. Safety instruction	3
5. Structure description	4
6. Lcd functions	5
7. Buttons description	7
8. Operation instruction	9
9. Operation steps and notices	14
10. Parameters and specifications	15
11. Online measurement	17
12. Battery replacement	18

1. INTRODUCTION

UT385 laser power meter is stable, safe and reliable tool for applications such as laboratories, laser device manufacturers and industrial enterprises.

2. FEATURES

- Precise laser sensor
- Split design with retractable spring wire, which is easy to operate
- LCD screen for clear readings
- Data storage function
- Selectable and customizable wavelengths
- Threshold alarm function
- Low power consumption

3. ACCESSORIES

Open the package and check if any item below is missing or damaged.

Device	1
9V battery	1
English manual	1
USB cable	1

4. SAFETY INSTRUCTION

- 1) Never stare into the laser beam directly or expose eyes to the reflected laser light, otherwise eyesight impairment or even blindness may occur. Especially the high-frequency laser, such as UV-light, is invisible by naked eyes and requires extra attention.
- 2) No laser over 40mW is allowed to input, the sensor may be damaged by high-power laser.
- 3) To avoid inaccurate measurement, please keep the sensor illuminated surface clean and free from scratch and contamination.
- 4) Check the device and accessories for any damage or abnormality before usage. Do not operate the product if you find it damaged obviously, no display or you suspect it is faulty.
- 5) Operating instruction must be followed during measurement.
- 6) Do not open the meter shell or change the internal circuit to avoid damage to the meter.
- 7) Users should change the battery in time when the icon  blinks on LCD. Remove the batteries during long-time storage to avoid battery leakage.
- 8) Do not use or store the meter in the environment of high temperature, high humidity, flammable, explosive or intense electromagnetic.
- 9) Clean the meter shell with a soft damp cloth and neutral detergent. Do not use abrasive or solvents, to protect the meter from corrosion.

5. STRUCTURE DESCRIPTION

- ① Device
- ② Buttons
- ③ LCD screen
- ④ USB interface
- ⑤ Sensor illuminated window (laser entrance)
- ⑥ Sensor protection cover
- ⑦ Probe handle
- ⑧ Probe handle holder
- ⑨ Spring wire

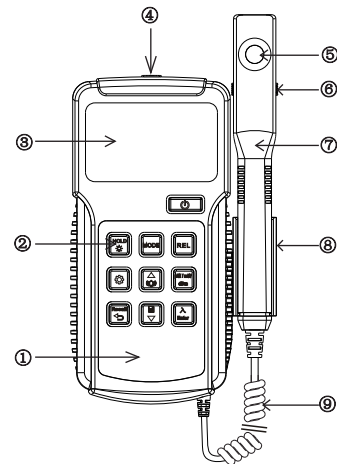

6. LCD FUNCTIONS

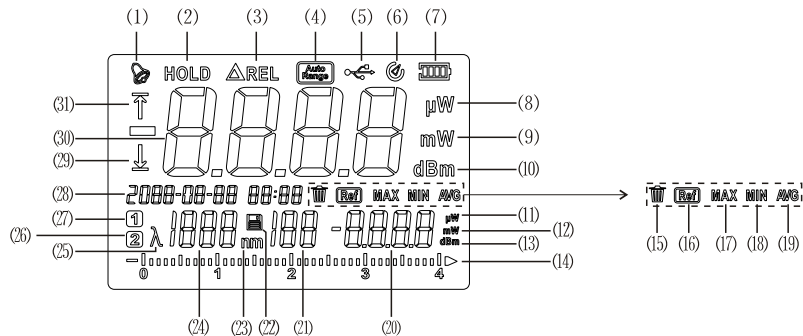

1	Audio alarm	17	Maximum measurement
2	Data hold	18	Minimum measurement
3	Relative value	19	Average measurement
4	Auto range	20	Secondary display area for maximum, minimum, average value and so on
5	USB connection	21	Data storage number
6	Auto power off	22	Data storage icon
7	Battery status	23	Wavelength unit nm
8	Unit μW (main display area)	24	Wavelength value
9	Unit mW (main display area)	25	Wavelength icon
10	Decibel unit dBm (main display area)	26	Customized wavelength number 1
11	Unit μW (secondary display area)	27	Customized wavelength number 2
12	Unit mW (secondary display area)	28	Date and time
13	Unit dBm (secondary display area)	29	Lower limit icon
14	Simulation bar	30	Main display area
15	Delete data	31	Upper limit icon
16	Obtain relative value		

7. BUTTONS DESCRIPTION

1) : Power on/off

In power off status, long press the button 1s to power on

In power on status, long press it 1s to turn on/off auto power off, short press to power off.

2) : HOLD/Backlight

Short press it to enter/exit HOLD mode. Long press it to turn on/off the backlight.

3) **MODE: MAX/MIN/AVG modes**

Short press it to switch between Maximum/Minimum/Average modes, and long press it to exit.

4) **REL: Relative Value**

Long press it to obtain relative value. Short press it to enter/exit the relative value mode.

5) : Settings

Short press it to enter setting mode. Short press  or  to switch the setting item according to the codes below.

S.dt: set date and time

S.dlt: set lower limit threshold

S.ult: set upper limit threshold

rSt?: restore settings

dEL?: delete saved data



Short press  button to exit the setting mode.

Short press  button to enter the according item's setting.

6) : Up/Audio Alarm

In normal measurement mode, long press the button to turn on/off audio alarm, and short press it to switch between upper/lower/upper and lower limit test modes or exit.

In setting mode, short press it to switch setting item or increase setting value.

Note: only upper limit will be detected when the icon  displays, and only lower limit will be detected when the icon  displays. Both the icons will be displayed when upper and lower limit test modes are turned on simultaneously.

7) : Switch units and Auto Range

Short press the button to switch between $\mu\text{W}/\text{mW}/\text{dBm}/\text{auto range}$ modes.

Note: the icon  displays during auto range mode, otherwise it is in manual range.

8) : Review/Return

Short press the button to enter storage data review mode or return.

9)  : Save/Down

In normal measurement mode, long press the button to save the current measured value, the icon  will blink if 199 groups of data storage have been fulfilled. Short press it to check the date and time. In setting mode, short press the button to switch setting item or decrease setting value.



10)  Enter: Wavelength/confirm

In normal measurement mode, short press the button to switch laser wavelength, and long press it to enter wavelength setting.





In date and time setting, short press this button to switch the digit position.

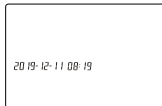

In setting mode, short press this button to confirm selection or enter the item.

8. OPERATION INSTRUCTION**1) Date and Time Setting**

Short press  to enter setting interface, switch to **S.dt** and short press  to enter date and time setting interface as figure below:



Short press  and  button to adjust setting value (long press to rapidly adjust). Short press  to move the cursor to the left, while short press  to move the cursor to the right.

After the setting is done, short press  button, the blinking of the icon  means the date and time setting is saved, then short press  to exit.

2) Upper/lower Limit Threshold Setting

Short press  to enter setting interface, select **S.dlt** and short press  to enter lower limit threshold setting interface as figure below:



In setting interface, select **S.ult** and short press  to enter upper limit threshold setting interface as figure below:



Short press \uparrow and \downarrow button to adjust setting value (long press to rapidly adjust). After the setting is done, short press the λ_{Enter} button to confirm and save the setting, or short press the Recall button to exit and not to save.

3) Relative Value Mode

Long press REL button to set current measured value as relative value and displays it in the secondary display area, as shown in figure:

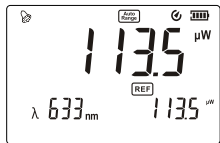

Short press REL button can enter relative value mode. It will subtract the relative value from the actual measuring value, the difference will be displayed in main display area as shown in figure:

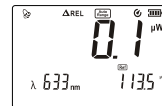

4) Customized Wavelength Setting

Long press λ_{Enter} to enter customized wavelength setting interface, 2 customized wavelength can be save as 1 and 2, which can be switched by \uparrow and \downarrow button.

Short press Recall to enter wavelength setting mode, the icon λ on LCD will blink as figure below:

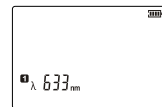

Short press or long press \uparrow or \downarrow button to set customized wavelength.

Short press λ_{Enter} to save the current setting wavelength, the showing of icon λ means the wavelength setting is saved, then short press Recall to exit.

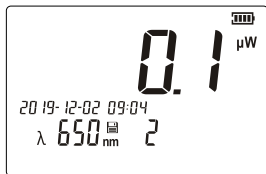

5) Review or Delete Storage Value

Short press  button to enter data review mode as shown in figure.





For example, the current storage data is:

- The storage serial number is 2.
- The measured data is 0.1μW.
- The wavelength is 650nm.
- The measured time is 09:04 (24-hour) 2nd December, 2019

Short press  and  to switch storage data. Short press  button to select specified data as figure below:



Then short press  button again to delete specified data, short press  to cancel deleting. After setting, short press  button to exit.

9. OPERATION STEPS AND NOTICES

- Power on the meter.
- Aim the laser at the middle illuminated surface of the sensor and keep the laser angle with the illuminated surface to be 90°, at this point, the reading is the measured laser power.
- According to the laser type, in case the measured laser output will be influenced by reflected light of illuminated surface, please twist the angle a little bit to avoid the direct reflection on the laser port.
- In weak laser measurement (<1nW), in order to avoid the affection of the light interference such as ambient light, it should be operated in a dark room.

10. PARAMETERS AND SPECIFICATIONS

1) Main Parameters

Function	Range	Resolution	Accuracy	Remarks
Laser power Measured range Accuracy	0 μ W~399.9 μ W	0.1 μ W	0 μ W~10.0 μ W: $\pm(5\%+0.3)$ 10.0 μ W~399.9 μ W: $\pm 5\%$	The meter calibrates by the wavelength of 633nm
	0.400mW~3.999mW	0.001mW	$\pm 5\%$	
	4.00mW~39.99mW	0.01mW		
	-40dBm~16dBm		Formula: dBm=10*lg (mW)	
Measured range	0 μ W~39.99mW			
Laser wavelength range	400nm~1100nm			
Laser wavelength options	520nm, 633nm, 650nm, 780nm			

2) General Specifications

- LCD display: 4-digit LCD display, maximum display value: 3999
- Over-range indication: OL will be displayed when the laser power exceeds the range of 39.99mW.
- MAX/MIN/AVG mode: maximum/minimum/average value and the icon of MAX/MIN/AVG will be displayed in MAX/MIN/AVG mode.
- Data hold function: the icon of HOLD will be displayed during data hold.
- Backlight: backlight can be turned on/off manually.
- Auto power off: the meter will automatically shut down if no action was detected out within 5 minutes and auto power off can be turned off.
- Sampling rate: 0.5s
- Data storage: maximum 199 sets of data can be saved.
- Impact resistance: 1m drop proof
- Battery requirement: 1*9V battery, new battery should be replaced in time if the low battery icon  shows on LCD.
- Product size: 198*104*35mm
- Weight: 319g (includes battery)

3) Environmental Conditions

- Indoor use
- Maximum altitude: 2000m
- Class of pollution: Class 2
- Operating humidity and temperature: 0°C~40°C ($\leq 85\%RH$)
- Storage humidity and temperature: -10°C~50°C ($\leq 75\%RH$)

4) Reference Standards

JJG 249-2004; GBT 1153-2012

11. ONLINE MEASUREMENT

- 1) Download the PC software according to the General Documents Download Instruction in accessories.
- 2) Connect the meter with PC by USB cable and make sure the battery is enough.
- 3) Real-time measured data can be sent and the saved data in meter can be downloaded by USB Interface. The report can be generated by these data.
- 4) Users can click the [Help] option in the software operating interface for Software User Manual.

12. BATTERY REPLACEMENT

- 1) Remove the screw of the battery cover as shown in figure:

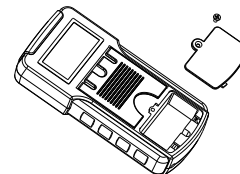

- 2) Load the 9V battery into the battery compartment correctly, close the cover and tighten the screw as figure:

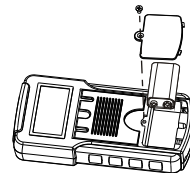

UNI-T®

UT385 User Manual

UNI-T®

UT385 User Manual

This manual is subject to change without prior notice.

UNI-T®

UNI-TREND TECHNOLOGY (CHINA) CO., LTD.

No. 6, Gong Ye Bei 1st Road,
Songshan Lake National High-Tech Industrial
Development Zone, Dongguan City,
Guangdong Province, China

Made in China

